

DEDICATION

STATE OF ARIZONA

COUNTY OF PINAL

KNOW ALL PERSONS BY THESE PRESENTS: THAT RDM MARICOPA, LLC, HAS SUBDIVIDED UNDER THE NAME THE LOFTS A SOUTHEAST QUARTER OF SECTION 21, TOWNSHIP 4 SOUTH, RANGE 3 EAST OF THE GILA AND SALT RIVER BASE AND MERIDIAN, PINAL COUNTY, ARIZONA, AS SHOWN AND PLATTED HEREON AND DOES HEREBY PUBLISH THIS PLAT AS AND FOR THE PLAT SETS FORTH THE LOCATION AND GIVES THE DIMENSIONS OF EACH LOT, TRACT, STREET, AND EASEMENT SHALL BE KNOWN BY THE NUMBER, LETTER, AND/OR NAME GIVEN TO EACH RESPECTIVELY AS SHOWN ON THIS PLAT.

OWNER HEREBY GRANTS TO GLOBAL - SANTA CRUZ WATER COMPANY A PERPETUAL NONEXCLUSIVE EASEMENT OVER, UNDER, UPON, AND ACROSS ALL AREAS DESIGNATED ON THE PLAT AS WATER/SEWER LINES, MANHOLES, FIRE HYDRANTS AND WATER METERS FOR THE PURPOSE OF INSTALLING, CONSTRUCTING, MAINTAINING, REPAIRING, REPLACING, AND UTILIZING AFORESAID UTILITIES.

KNOW ALL PERSONS BY THESE PRESENTS:

THAT RDM MARICOPA, LLC, HAS SUBDIVIDED UNDER THE NAME "THE LOFTS ON EDISON" A LOT 1 BLOCK 3 OF NORTH MARICOPA RECORDED IN BOOK 3 OF MAPS PAGE 008 EXCEPT THE NORTHERN 38.00 FT FOR ROW KNOWN AS EDISON ROAD IN MAP OF DEDICATION OF EDISON ROAD AND ABANDONMENT OF TAFT AVE IN FEE 2012-077122, ALL IN SECTION 21 TOWNSHIP 04 SOUTH RANGE 03 EAST, ARIZONA AS SHOWN AND PLATTED HEREON AND DOES HEREBY PUBLISH THIS PLAT AS AND FOR THE PLAT OF "THE LOFTS ON EDISON", AND DECLARES THAT THIS PLAT SETS FORTH THE LOCATION AND GIVES THE DIMENSIONS OF EACH LOT, AND THAT EACH LOT SHALL BE KNOWN BY THE NUMBER, LETTER, AND/OR NAME GIVEN TO EACH RESPECTIVELY AS SHOWN ON THIS PLAT.

THE MAINTENANCE OF LANDSCAPING WITHIN THE PUBLIC RIGHT-OF-WAY TO BACK OF CURB SHALL BE THE RESPONSIBILITY OF THE HOMEOWNERS' ASSOCIATION OR THE ABUTTING PROPERTY OWNER. ALL PROPERTY, AMENITIES AND FACILITIES PROPOSED TO BE MAINTAINED BY THE HOMEOWNERS' ASSOCIATION ARE HEREWITH PLATTED AS COMMON PROPERTY WITH AN UNDIVIDED INTEREST OWNED IN COMMON BY EACH LOT OWNER.

OWNER HEREBY GRANTS TO THE CITY OF MARICOPA A PERPETUAL CROSS ACCESS EASEMENT ACROSS THE PLAT INCLUDING ROADS AND STREETS, OPEN SPACES, COMMUNITY FACILITIES, TRACTS, SIDEWALKS, DRAINAGE BASINS AND ANY PROPERTY WITHIN THE PLAT OWNED BY THE HOMEOWNERS ASSOCIATION FOR THE PURPOSE OF PROVIDING CONTINUOUS AND UNINTERRUPTED INGRESS AND EGRESS FOR EMERGENCY VEHICLES.

OWNER HEREBY GRANTS TO THE PUBLIC A PERPETUAL NON-EXCLUSIVE EASEMENT IN, UPON, OVER, UNDER, THROUGH, AND ACROSS THE AREAS DESIGNATED AS PUBLIC UTILITY EASEMENTS AS SHOWN ON THE PLAT FOR THE PURPOSE OF ACCESSING, INSTALLING, CONSTRUCTING, MAINTAINING, REPAIRING, REPLACING, AND UTILIZING PUBLIC UTILITIES.

ALL TRACTS THAT WILL NOT BE DEDICATED TO THE CITY OF MARICOPA AND ALL COMMON PROPERTY SHALL BE IMPROVED IN ACCORDANCE WITH PLANS APPROVED BY THE CITY OF MARICOPA AND SHALL BE CONVEYED BY WARRANTY (OR SPECIAL WARRANTY) DEED TO THE HOMEOWNERS' ASSOCIATION. THE HOMEOWNERS' ASSOCIATION SHALL BE RESPONSIBLE FOR THE MAINTENANCE OF COMMON PROPERTY.

ANY STREET DESIGNATED ON THIS PLAT AS PRIVATE STREET WILL REMAIN PRIVATE.

ANY OBJECT, WALL, STRUCTURE, MOUND OR LANDSCAPING (MATURE) OVER 24" IN HEIGHT IS NOT ALLOWED WITHIN THE VISIBILITY EASEMENT.

CONSTRUCTION WITHIN UTILITY EASEMENTS SHALL BE LIMITED TO UTILITIES, FENCES AND DRIVEWAYS. NO STRUCTURES OR VEGETATION OF ANY KIND THAT WOULD IMPEDE THE FLOW OF WATER THROUGH THE EASEMENT MAY BE CONSTRUCTED, PLANTED OR ALLOWED TO GROW WITHIN DRAINAGE EASEMENTS.

INDIVIDUAL PROPERTY OWNERS, AND/OR PROPERTY OWNERS' ASSOCIATION SHALL PROPERLY MAINTAIN ALL STREET LIGHTING, LANDSCAPE MATERIALS AND LANDSCAPED AREAS, INCLUDING THAT WITHIN THE PUBLIC RIGHTS-OF-WAY ADJACENT TO THE DEVELOPMENT, IN ACCORDANCE WITH THE APPROVED LANDSCAPE PLAN.

REPLACEMENT OF DEAD TREES ALONG ARTERIAL, COLLECTOR, AND LOCAL STREETS SHALL BE BY THE INDIVIDUAL PROPERTY OWNERS OR THE HOMEOWNERS' ASSOCIATION AND SHALL BE COMPLETED WITHIN THREE (3) MONTHS FROM THE DATE THAT THE ASSOCIATION OR PROPERTY OWNER IS NOTIFIED BY THE CITY.

THE OVERHEAD UTILITY LINES AND ELECTRIC LINES ON OR ADJACENT TO THIS SITE MUST BE UNDER-GROUNDED.

IN WITNESS WHEREOF: RDM MARICOPA, LLC, AN ARIZONA LIMITED LIABILITY COMPANY, AS OWNER, HAS HEREBY CAUSED THEIR NAME TO BE AFFIXED AND THE SAME ATTESTED BY THE SIGNATURE OF THE UNDERSIGNED OFFICER.

RDM MARICOPA LLC, AN ARIZONA LIMITED LIABILITY COMPANY

TRACT A ARE NOT DEDICATED TO THE PUBLIC, BUT ARE PLATTED AS COMMON PROPERTY WITH AN UNDIVIDED INTEREST OWNED IN COMMON BY EACH LOT OWNER FOR LOT OWNER USE AND ENJOYMENT AS MORE FULLY SET FORTH IN THE DECLARATION OF COVENANTS, CONDITIONS, AND RESTRICTIONS.

BY: MERLIN ROWLEY

ITS:

NOTES

- 1. NOTE TO THE CLIENT, INSURER, AND LENDER - WITH REGARD TO TABLE A, ITEM 11, INFORMATION FROM THE SOURCES CHECKED ABOVE WILL BE COMBINED WITH OBSERVED EVIDENCE OF UTILITIES PURSUANT TO SECTION 5.E.IV. TO DEVELOP A VIEW OF THE UNDERGROUND UTILITIES. HOWEVER, LACKING EXCAVATION, THE EXACT LOCATION OF UNDERGROUND FEATURES CANNOT BE ACCURATELY, COMPLETELY, AND RELIABLY DEPICTED. IN ADDITION, IN SOME JURISDICTIONS, 811 OR OTHER SIMILAR UTILITY LOCATE REQUESTS FROM SURVEYORS MAY BE IGNORED OR RESULT IN AN INCOMPLETE RESPONSE, IN WHICH CASE THE SURVEYOR SHALL NOTE ON THE PLAT OR MAP HOW THIS AFFECTED THE SURVEYOR'S ASSESSMENT OF THE LOCATION OF THE UTILITIES. WHERE ADDITIONAL OR MORE DETAILED INFORMATION IS REQUIRED, THE CLIENT IS ADVISED THAT EXCAVATION MAY BE NECESSARY.
- 2. NO OBSERVABLE EVIDENCE OF EARTH MOVING WORK, BUILDING CONSTRUCTION OR BUILDING ADDITIONS WITHIN RECENT MONTHS.
- 3. NO STRUCTURES OR VEGETATION OF ANY KIND THAT WOULD IMPEDE THE FLOW OF WATER THROUGH THE EASEMENTS MAY BE CONSTRUCTED, PLANTED OR ALLOWED TO GROW WITHIN DRAINAGE EASEMENTS.
- 4. INDIVIDUAL PROPERTY OWNERS, AND/OR PROPERTY OWNERS' ASSOCIATION SHALL PROPERLY MAINTAIN ALL STREET LIGHTING, LANDSCAPE MATERIALS AND LANDSCAPED AREAS, INCLUDING THAT WITHIN THE PUBLIC RIGHT-OF-WAY ADJACENT TO THE DEVELOPMENT, IN ACCORDANCE WITH THE APPROVED LANDSCAPE PLAN.
- 5. REPLACEMENT OF DEAD TREES ALONG ARTERIAL, COLLECTOR, AND LOCAL STREETS SHALL BE BY THE INDIVIDUAL PROPERTY OWNERS OR THE HOMEOWNERS' ASSOCIATION AND SHALL BE COMPLETED WITHIN THREE (3) MONTHS FROM THE DATE THAT THE ASSOCIATION OR PROPERTY OWNER IS NOTIFIED BY CITY.
- 6. THE OVERHEAD UTILITY LINES AND ELECTRIC LINES ON OR ADJACENT TO THIS SITE MUST BE UNDER GROUNDED.

ACKNOWLEDGMENT

STATE OF ARIZONA S.S. COUNTY OF PINAL

ON THIS DAY OF 2023, BEFORE ME, THE UNDERSIGNED, PERSONALLY APPEARED WHO ACKNOWLEDGED SELF TO BE THE PERSON WHOSE NAME IS SUBSCRIBED TO THE INSTRUMENT WITHIN, AND WHO EXECUTED THE FOREGOING INSTRUMENT FOR THE PURPOSES THEREIN CONTAINED.

IN WITNESS THEREOF, I HAVE HEREUNTO SET MY HAND AND OFFICIAL SEAL.

DATE

NOTARY PUBLIC

MY COMMISSION EXPIRES: 2023

FLOOD INSURANCE RATE MAP (F.I.R.M.) INFORMATION

COMMUNITY NUMBER	PANEL NUMBER	SUFFIX	FIRM DATE (INDEX DATE)	FIRM ZONE
04021C	735	F	06/16/14	X

FINAL PLAT FOR THE LOFTS ON EDISON
SOUTHEAST QUARTER OF SECTION 21, TOWNSHIP 4 SOUTH, RANGE 3 EAST OF THE GILA AND SALT RIVER BASE AND MERIDIAN, PINAL COUNTY, ARIZONA

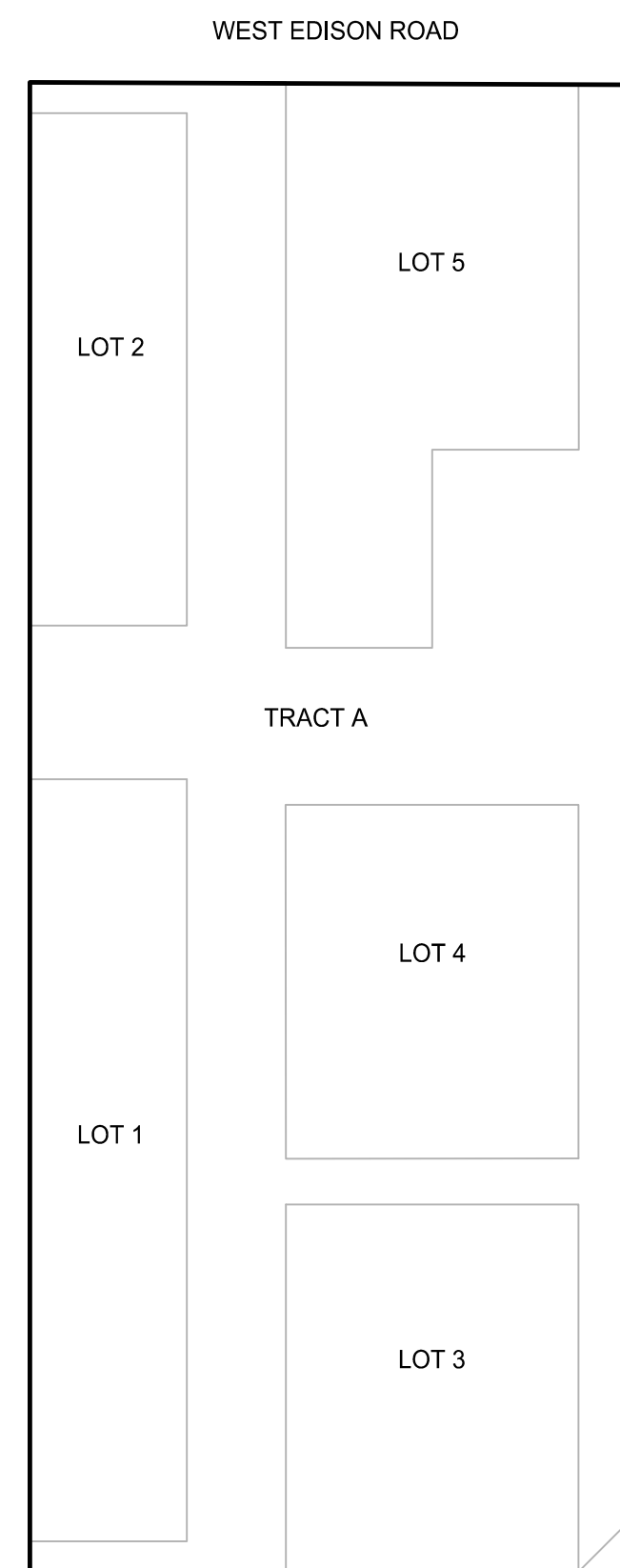

INDEX MAP
SCALE 1:60

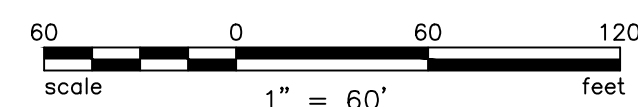

SHEET INDEX

- 1..... COVER SHEET
- 2..... FINAL PLAT

LEGAL DESCRIPTION

LOT 1, BLOCK 3, NORTH MARICOPA, ACCORDING TO THE PLAT OF RECORD IN THE OFFICE OF THE COUNTY RECORDER OF PINAL COUNTY, ARIZONA, RECORDED IN BOOK 3 OF MAPS, PAGE 8, MORE PARTICULARLY DESCRIBED AS FOLLOWS: A PARCEL OF LAND LOCATED IN THE SOUTHEAST QUARTER OF SECTION 21, TOWNSHIP 4 SOUTH RANGE 3 EAST OF THE GILA AND SALT RIVER BASE AND MERIDIAN, PINAL COUNTY, ARIZONA MORE PARTICULARLY DESCRIBED AS FOLLOWS: COMMENCING AT THE EAST QUARTER CORNER OF SAID SECTION 21 FROM WHENCE THE SOUTHEAST CORNER LIES SOUTH 0 DEGREES 0 MINUTES 05 SECONDS EAST, A DISTANCE OF 2,628.08 FEET; THENCE ALONG THE NORTH LINE OF THE SOUTHEAST QUARTER OF SAID SECTION 21, SOUTH 89 DEGREES 36 MINUTES 41 SECONDS WEST, A DISTANCE OF 1,398.47 FEET; THENCE DEPARTING SAID LINE, SOUTH 0 DEGREES 38 MINUTES 0 SECONDS EAST, A DISTANCE OF 40.00 FEET TO A POINT COINCIDENT WITH THE INTERSECTION OF THE EAST LINE OF LOT 1 IN BLOCK 3 OF "NORTH MARICOPA" ACCORDING TO BOOK 3 OF MAPS, PAGE 8, AND THE SOUTH RIGHT OF WAY LINE OF WEST EDISON ROAD ACCORDING TO FEE #2012-077122, ON FILE IN THE OFFICE OF THE RECORDER OF PINAL COUNTY, ARIZONA. SAID POINT BEING THE POINT OF BEGINNING; THENCE ALONG THE EAST LINE OF SAID LOT 1, SOUTH 0 DEGREES 38 MINUTES 1 SECOND EAST, A DISTANCE OF 487.66 FEET TO A POINT COINCIDENT WITH THE SOUTHEAST CORNER OF SAID LOT 1; THENCE ALONG THE SOUTH LINE OF SAID LOT 1, SOUTH 89 DEGREES 21 MINUTES 28 SECONDS WEST, A DISTANCE OF 199.96 FEET, TO A POINT COINCIDENT WITH THE SOUTHWEST CORNER OF SAID LOT 1; THENCE ALONG THE WEST LINE OF SAID LOT 1, NORTH 0 DEGREES 37 MINUTES 41 SECONDS WEST, A DISTANCE OF 488.55 FEET TO A POINT COINCIDENT WITH SAID RIGHT OF WAY LINE OF WEST EDISON ROAD; THENCE ALONG SAID RIGHT OF WAY LINE, NORTH 89 DEGREES 36 MINUTES 41 SECONDS EAST, A DISTANCE OF 199.91 FEET TO THE POINT OF BEGINNING, CONTAINING 97,588.40 SQUARE FEET OR 2.2403 ACRES, MORE OR LESS.

BASIS OF BEARING

THE EAST LINE OF THE SOUTHEAST QUARTER OF SECTION 21, TOWNSHIP 4 SOUTH, RANGE 3 EAST OF THE GILA AND SALT RIVER BASE AND MERIDIAN, PINAL COUNTY, ARIZONA BEARING S00°00'05"E. (ASSUMED BEARING)

BENCHMARK

4" B.L.M. BRASS CAP FOUND IN THE SOUTHWEST QUARTER OF SECTION 21, TOWNSHIP 4 SOUTH, RANGE 3 EAST, OF THE GILA AND SALT RIVER BASE AND MERIDIAN, PINAL COUNTY, ARIZONA. ELEVATION = 1168.52' (NAVD 88 DATUM)

ASSURANCE STATEMENT

ASSURANCE IN THE FORM OF A PERFORMANCE BOND, ISSUED FROM

IN THE AMOUNT OF \$ HAS BEEN DEPOSITED WITH THE CITY ENGINEER TO GUARANTEE CONSTRUCTION OF THE REQUIRED SUBDIVISION IMPROVEMENTS.

SURVEYOR'S CERTIFICATION:

THIS IS TO CERTIFY THAT THIS PLAT IS CORRECT AND ACCURATE AND THE MONUMENTS DESCRIBED HEREIN HAVE EITHER BEEN SET OR LOCATED AS DESCRIBED TO THE BEST OF MY KNOWLEDGE AND BELIEF.

CD Harvey 08/15/23
HARVEY LAND SURVEYING, INC COLIN D. HARVEY P.O BOX 10772 CASA GRANDE, ARIZONA, 85130 DATE

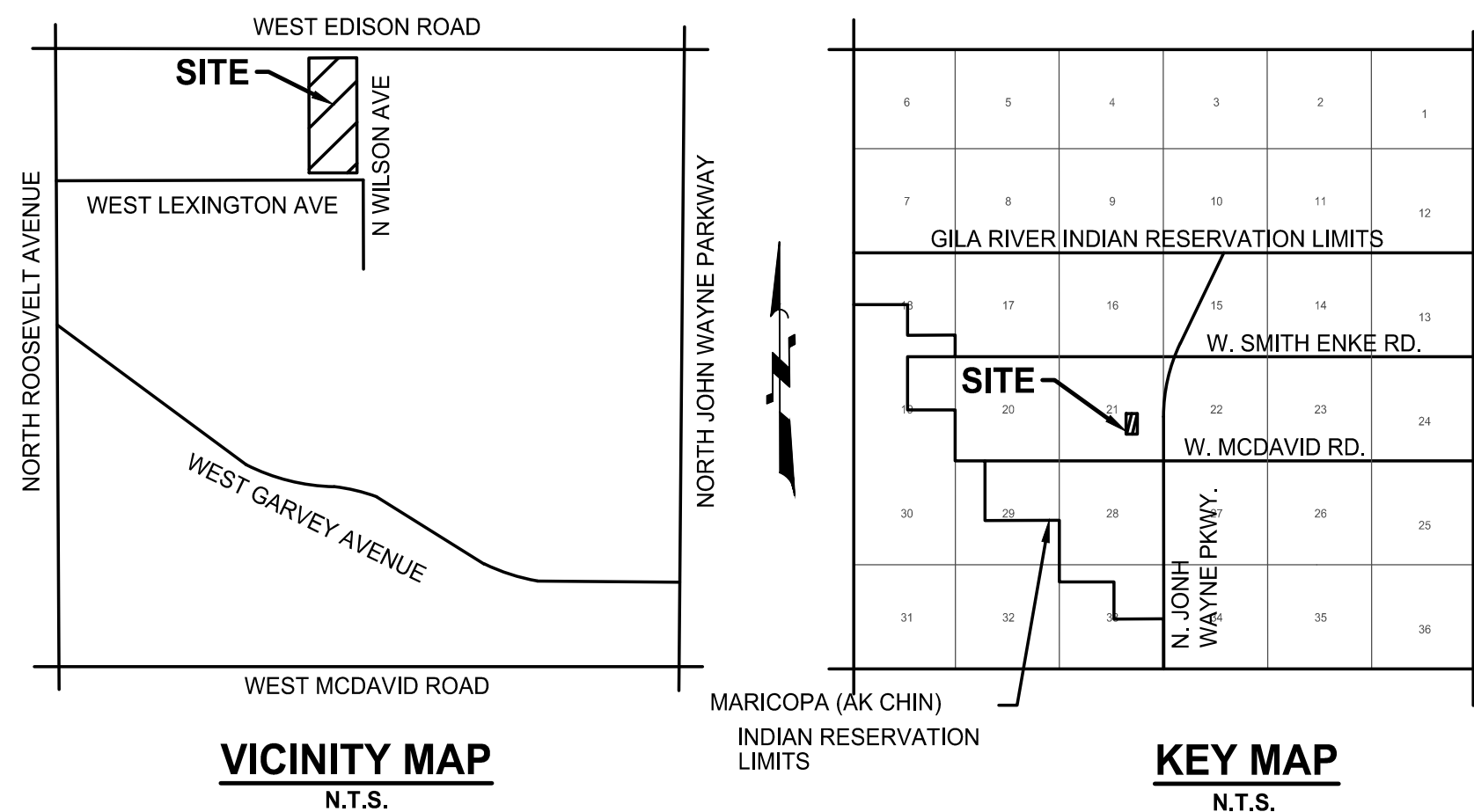

OWNER

RDM MARICOPA, LLC 13404 S. 33RD CT PHOENIX, AZ 85044 ATTN: MERLIN ROWLEY

SURVEYOR

HARVEY LAND SURVEYING, INC. P.O. BOX 10772 CASA GRANDE, ARIZONA, 85130 PHONE: 520.87.4786 E-MAIL: COLEHARVEY@HARVEYSURVEYING.COM

SITE DATA

GROSS AREA: 2.94 AC (128,312 SF) NET AREA: 2.24 AC (97,589 SF)

APN

APN: 510-20-0430

DEVELOPMENT SERVICES DIRECTOR APPROVAL

APPROVED:

DEVELOPMENT SERVICES DIRECTOR CITY OF MARICOPA, ARIZONA DATE

CITY ENGINEER'S APPROVAL

APPROVED:

CITY ENGINEER CITY OF MARICOPA, ARIZONA DATE

COUNCIL OF THE CITY APPROVAL

APPROVED BY THE COUNCIL OF THE CITY OF MARICOPA, ARIZONA, THIS DAY OF 2023.

BY: MAYOR DATE

ATTEST: CITY CLERK DATE

Harvey Land Surveying, Inc. 461 E. Dartmouth Dr. Casa Grande, Arizona 85122 (520) 876-0212

REVISIONS table with columns for revision number and description.

COVER SHEET THE LOFTS ON EDISON 20390 N. WILSON AVE., MARICOPA, AZ 85139 PROJECT:

Job No., Drawn By, Checked table.

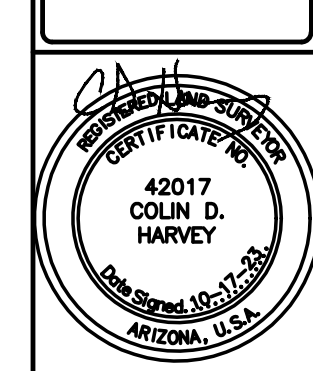
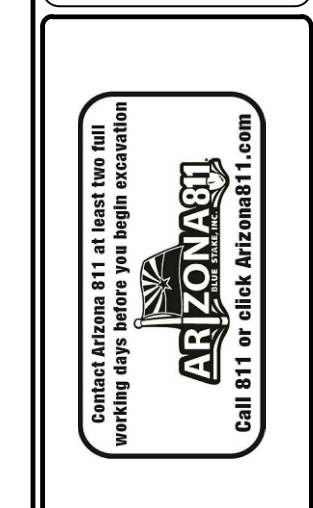

JOB NO., FINAL PLAT, SHEET NO. 1, 1 OF 2

C:\Users\cdoyle\OneDrive\Documents\Surveying\Projects\2023\081523\LOFTS ON EDISON\DWG\CIVIL\FINAL DESIGN\FINAL PLAT\2023-08-25\FP01.dwg, 10/17/2023 10:07:19 AM

C:\Users\jdoivda\OneDrive\Documents\Projects\2023\02\202310060 THE LOFTS ON EDISON\DWG\CIVIL\FINAL DESIGN\FINAL PLAT\2023-09-25\F02.dwg, 10/18/2023 3:57:31 PM

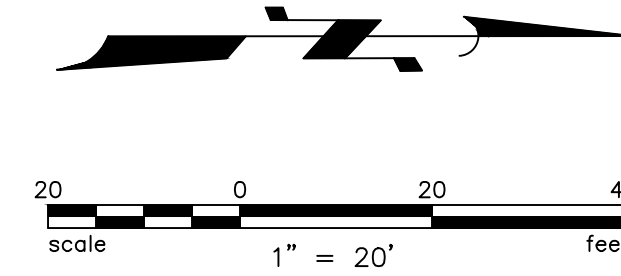

NORTHWEST CORNER
"NORTH MARICOPA" POSITION
CALCULATED PER BK 3 OF
MAPS, PAGE 8, PCR.
CENTER QUARTER CORNER
SEC 21 T4S R3E
NOTHING FOUND POSITION
CALCULATED PER FEE #
2017-020720, PCR, AND
FOUND MONUMENTS

APN: 510-20-0440
LOT 2
PARAGON HAMPTON EDISON LLC

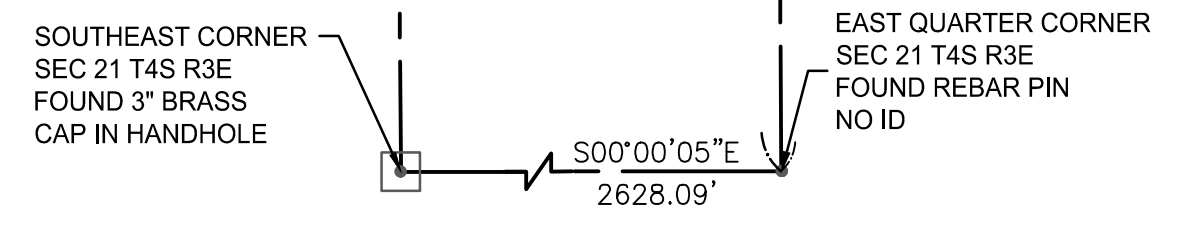
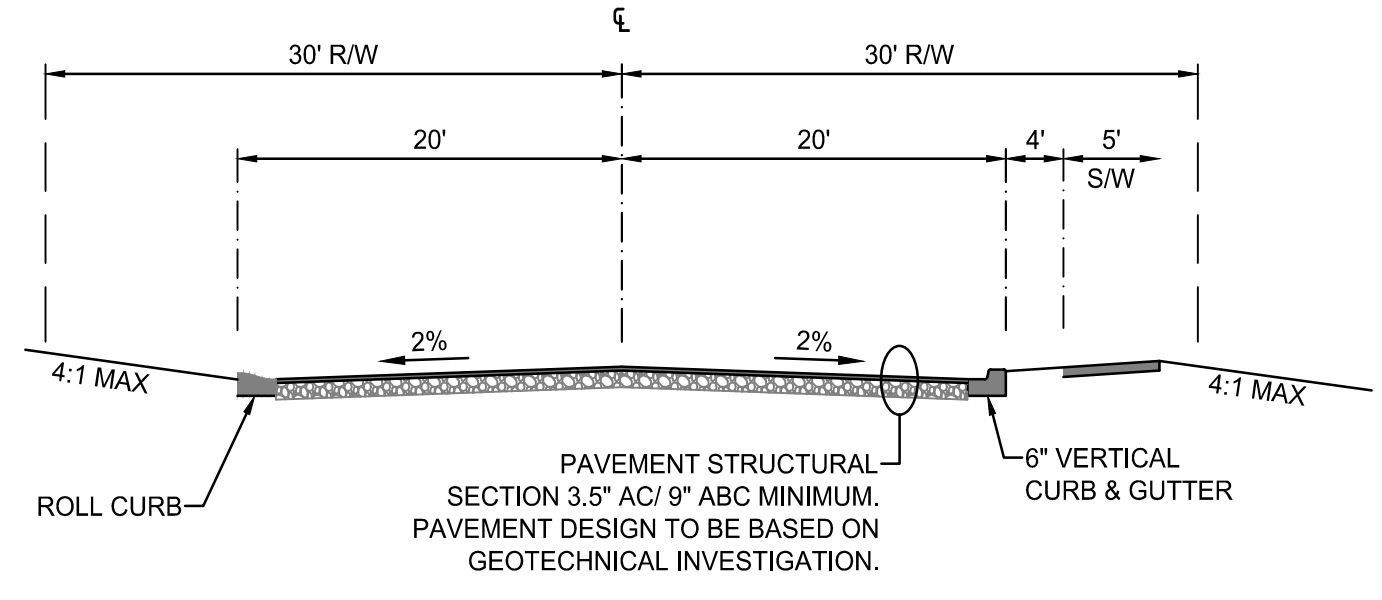
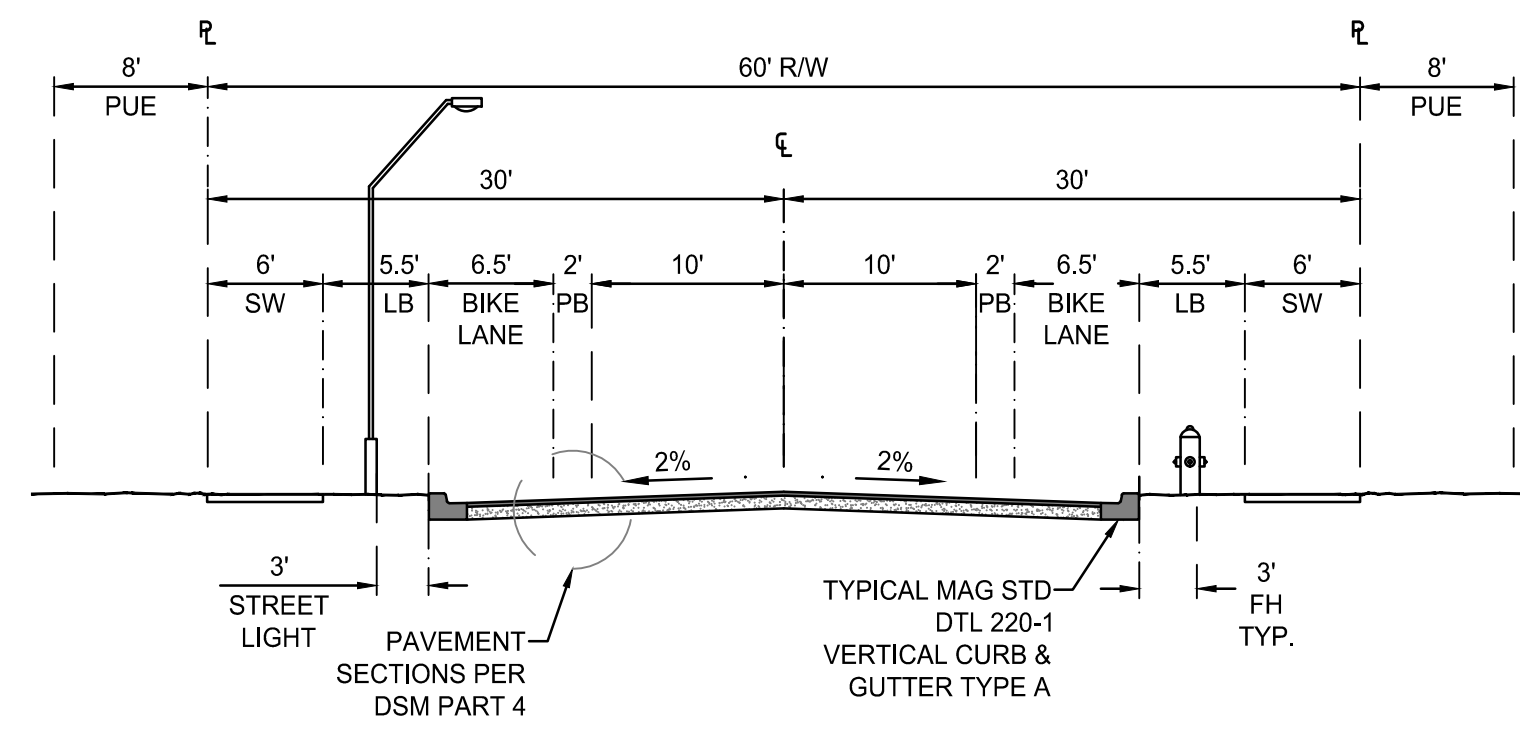
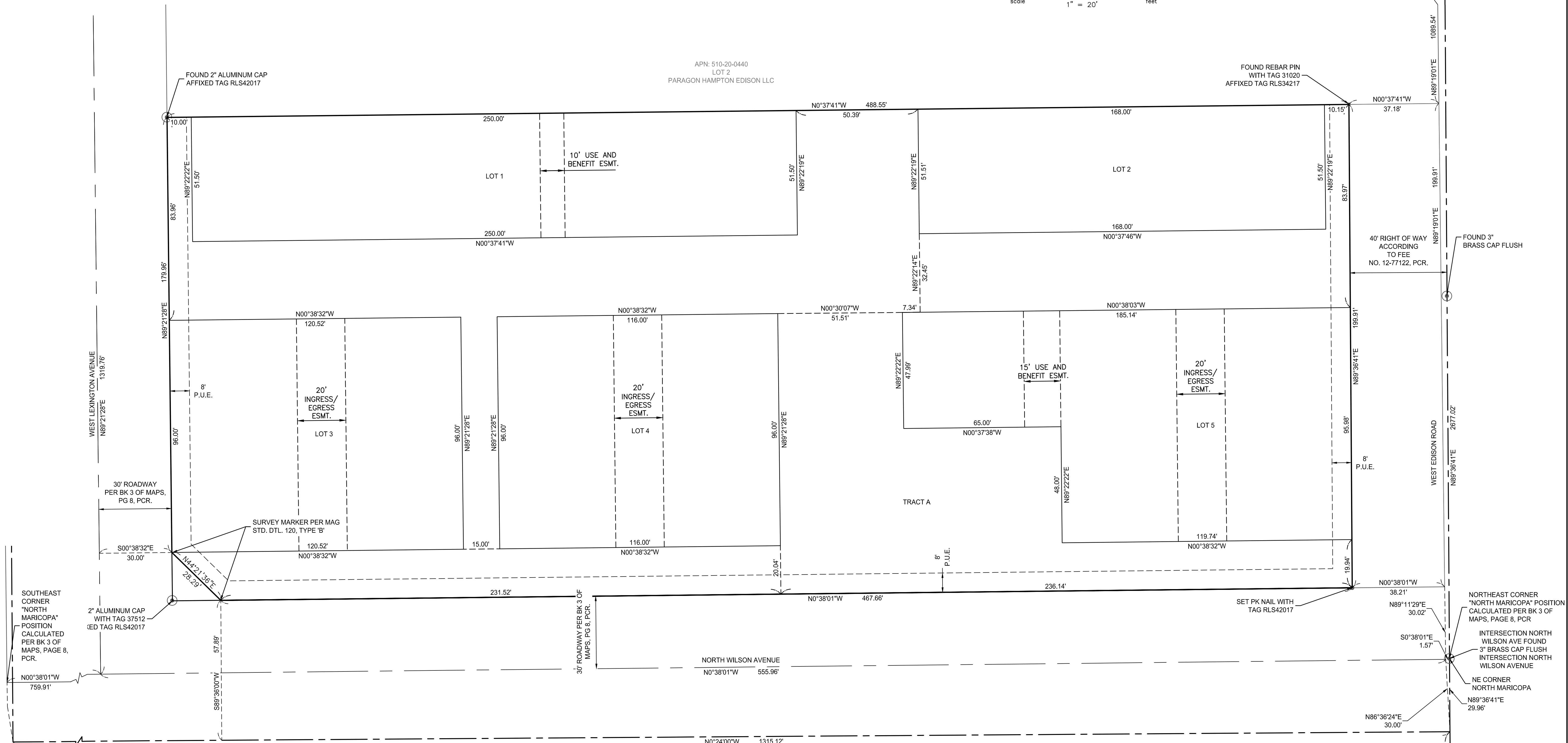

LOT TABLE		
LOT#	S.F.	AC
1	12874.98	0.30
2	8653.02	0.20
3	11569.90	0.27
4	11136.00	0.26
5	14632.17	0.34

TRACT TABLE		
TRACT	ACRES	AREA SQ. FT.
TRACT A	0.88	38522.74

LEGEND
 LB LANDSCAPE BUFFER
 PB PAINTED BUFFER
 PUE PUBLIC UTILITY EASEMENT
WILSON AVENUE
 CITY OF MARICOPA DETAIL NO. MAR-205-1
 "COLLECTOR STREET - 60' ROW"
 N.T.S.

LEXINGTON AVENUE
 "MINOR COLLECTOR - 30' ROW"
 N.T.S.

Harvey Land Surveying, Inc.
 461 E. Dartmouth Dr.
 Casa Grande, Arizona 85122
 (520) 876-0212

REVISIONS:

FINAL PLAT
THE LOFTS ON EDISON
 20390 N. WILSON AVE., MARICOPA, AZ 85139

Job No.:
 Drawn By: AEA
 Checked: DB

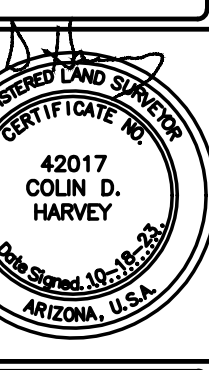

JOB NO.
 FINAL PLAT
 SHEET NO.
2
 2 OF 2